

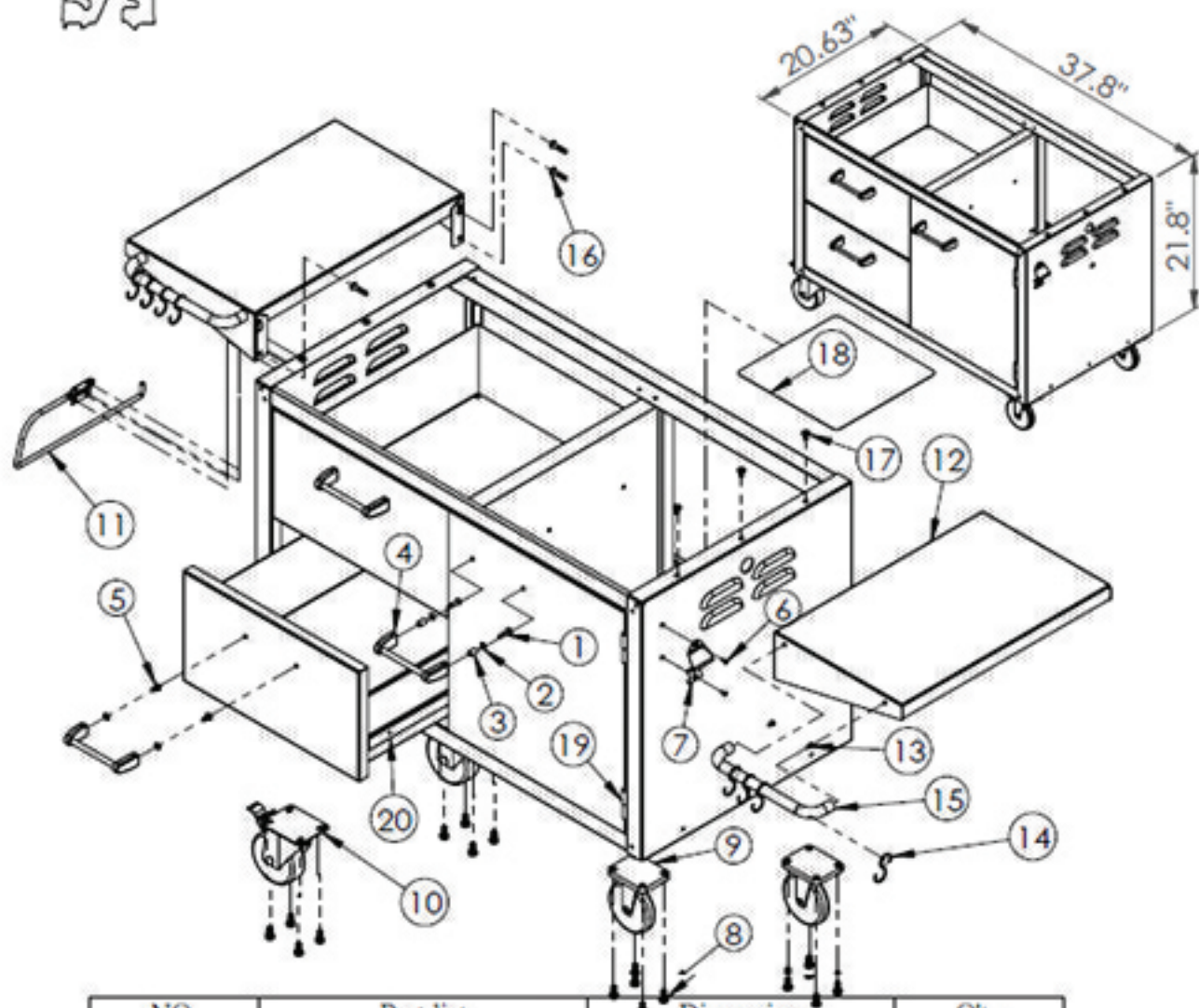









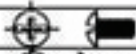
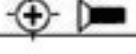

SPECIFICATIONS & ASSEMBLY INSTRUCTION

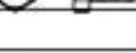
ITEM #L963872 CART FOR L90000



NO.	Part list	Dimension	Q'ty
1	Truss Head Screw	1/4"x28L 	2
2	Washer	Ø 13 	6
3	Sleeve	Ø 9.5 	2
4	Handle		3
5	Truss Head Screw	1/4"x1/2"L 	4
6	Flat Head Screw	M4*12L 	2
7	Bottle Opener		1
8	Hexagon Screw	3/8"x5/8" 	16
9	4" Caster		2
10	4" Caster W/Brake		2
11	Towel Holder		1
12	shelf		2
13	Truss Head Screw	M6x12L 	4
14	S Hook		8
15	Handle of side shelf	Ø 19 	2
16	Hex Washer Head Screw	M5x15L 	6
17	Truss Head Screw	1/4"x1/2"L 	6
18	Bottom Panel of Gas Tank		1
19	Hinge		4
20	Roller Guides		4